

LEDs

5mm Round – White

HL-9658

Package Configuration

Descriptions:
Emitting Color: White
Device Outline: Φ 5mm round type
Lens Type: Water Clear

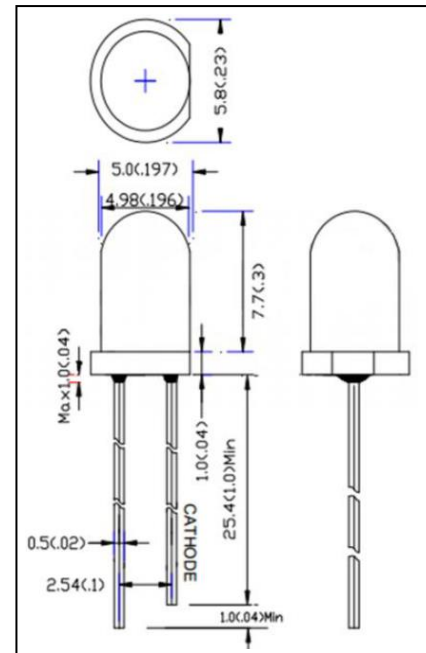

Absolute Maximum Ratings (Ta=25°C)

Parameter	Max.	Unit.
Peak Forward Current (1/10 Duty Cycle, 0.1ms Pulse Width)	100	mA
Continuous Forward Current	20	mA
Reverse Voltage	5	V
Operating Temperature Range	-40 °C to +85°C	
Storage Temperature Range	-40 °C to +100°C	
Lead Soldering Temperature[4mm(.157") From Body]	250°C for 5 Seconds	

Electrical and optical characteristics

Parameter	Symbol	Min.	Typ.	Max.	Unit.	Test Condition
Luminous Intensity	I_v	-	5000	-	mcd	$I_f=20mA$
Viewing Angle	$2\theta_{1/2}$	-	25	-	deg.	
Color Temperature	-	-	8500	-	K	